

# An Indicator for Separation of Structural and Harmonic Modes in Output-Only Modal Testing

*Rune Brincker*

*Department of Building Technology and Structural Engineering  
Aalborg University  
Sonngaardsholmsvej 57, DK 9000, Aalborg, Denmark*

*Palle Andersen*

*Structural Vibration Solutions ApS  
NOVI Science Park,  
Niels Jernes Vej 10, DK 9220 Aalborg East, Denmark*

*Nis Møller*

*Sound and Vibration Measurement A/S  
Brüel and Kjær  
Skodsborgvej 307, DK-2850. Nærum, Denmark*

## Abstract

**In this paper a technique for separation of harmonic and structural modes in output-only modal testing and identification is presented. The indicator is based on the basic differences of the statistical properties of a harmonic response and narrow-band stochastic response of a structural mode. The indicator is demonstrated on an example where a plate is loaded by an engine rotating with quasi-stationary speed. An output-only modal identification is performed using a technique based on Frequency Domain Decomposition (FDD), and what appears to be three harmonic components and five structural modes were identified.**

## Nomenclature

$\Delta t$	sampling time step
$y_i$	response vector
$f$	natural frequency
$\zeta$	damping ratio
$\Phi, \Psi$	mode shape matrices

## Introduction

When modal properties are to be identified from large structures in operation, usually the possibilities to control and measure the loading on the structure is rather limited. In this case, the modal testing and identification is usually performed using response data only.

This is especially true for many large civil engineering structures such as buildings, bridges and offshore structures. In civil engineering this technique is denoted ambient response testing or ambient response analysis. Several real cases of ambient response analysis can be found in Ventura and Horyna [1], and a comparison between different techniques for modal identification from ambient responses can be found in Andersen et al. [2].

In mechanical applications however, the traditional methods have concentrated on techniques where the input is controlled and measured, Ewins [3], Maia et al. [4]. Usually, in this case, the tests are performed under conditions where the response from the non-controllable loads are minimised. However, in many applications in mechanical engineering, modal identification would be easier if the modal testing could take place with the structure and eventually rotating machinery in operation. In mechanical engineering usually this kind of identification is denoted output-only modal identification or in-operation modal identification.

The general case considered in this paper, is a case where a structure is loaded by rotating machinery and a modal testing and identification is to be carried out based on the responses only. Thus, no artificial loading is used, the structure is loaded only by the rotating machinery and other natural sources of excitation.

When any rotating machinery is loading a structure, the structure is loaded by a combination of harmonic components and a stochastic background noise that looks more like a coloured white noise loading. This background noise might come from bearings in the rotating machinery, from explosions (if the rotating machinery is for instance a diesel engine) or from other sources such as vibrations from other types of equipment, traffic etc.

The response due to the stochastic loading can be treated using the classical techniques in ambient response analysis or output modal identification. However, the harmonics will create some problems in the identification process. If parametric models are used, like for instance a kind of Stochastic Subspace Identification (SSI) technique, see for instance Overschee [6], then the harmonics will be identified as structural modes. Also for frequency domain techniques like the Frequency Domain Decomposition (FDD) technique used in this paper, there is nothing in the identification process itself that clearly separates a harmonic from a narrow-band stochastic structural response.

For this reason, when applying output-only modal testing and identification on real cases, where rotating machinery is often in operation during measurements of the response, it is important to have some additional tools available for separation of harmonics and structural modes.

In this paper a simple technique is presented that is based on the basic differences of the stochastic properties of a harmonic and a stochastic structural response. The indicator is demonstrated on an example where a plate is loaded by an engine rotating with quasi-stationary speed. An output-only modal identification is performed using a technique based on Frequency Domain Decomposition (FDD), and what appears to be three harmonic components and five structural modes are identified.

## Theoretical Background of Harmonic Indicator

The statistical properties of a harmonic response and a stochastic structural response is quite different. The probability density function of a harmonic response is a distribution with two peaks whereas the probability density function of a stochastic structural response is a distribution with only one peak. Thus, the empirical probability density function for a mode under consideration constitutes a natural indicator for harmonic/structural response. This indicator has also been proposed by Lagö [7].

Any structure loaded by any kind of stochastic loading will under some mild restrictions produce a response with a probability density function that is close to a Gaussian distribution. This is easily concluded from the central limit theorem that states that any linear combination of a large number of random variables tends to a normal distribution independently of the statistical properties of the variables, Papoulis [8]. Thus, if any structure is loaded by a sufficiently large number of independent loading sources, the response will always be approximately Gaussian. This is true independently of what is done to the signal, like filtering, decimation etc. The zero mean Gaussian

probability density function with unit standard deviation is shown in Figure 1.

The probability density function of a harmonic response is even more well defined. If the stochastic variables  $X$  and  $Y$  with the corresponding probability density functions  $f(x), g(y)$  are related by  $y = h(x)$ , then the following well known relation exists:

$$g(y) = f(x) / h'(x) \quad (1)$$

where  $h'(x)$  is the derivative of  $h(x)$ , Papoulis [8]. Now taking the density function of  $X$  as uniform, this leads to the probability density function for a harmonic response with amplitude  $a$

$$g(y) = (\pi \cos(\arcsin(y/a)))^{-1} \quad (2)$$

The probability density function of a zero mean harmonic response with unit standard deviation is shown in Figure 1 below. The density function goes to infinity as  $y \rightarrow a$  or  $y \rightarrow -a$ . Thus, the density function has two distinct peaks. As it appears, this result is true for any frequency, i.e. also for a case with slowly varying frequency. As long as the amplitude is constant and the response remains harmonic, Equation (2) holds exactly.

## Example, Plate Excited by Engine

The test case considered here is a plate loaded by an engine. The plate geometry and the transducer placement is shown in Figure 2. 8 accelerometers, were placed to measure the out-of-plane deformations of the plate.

The plate was placed horizontally on soft supports approximating free-free conditions. An electrical motor was mounted on the plate, and the speed was varied slowly around 5400 RPM. No other loading was applied to the plate.

The responses were measured using a Brüel & Kjær PULSE™ multi-analysis system with a sampling rate of 2048 samples per second. The length of the time series were 16384 data points per channel corresponding to exactly 8 seconds of data.

## Principle of Frequency Domain Decomposition (FDD)

The Frequency Domain Decomposition (FDD) technique is an extension of the classical frequency domain approach often referred to as the Basic Frequency Domain (BFD)

technique, or the peak picking technique. The classical approach is based on simple signal processing using the Discrete Fourier Transform, and is using the fact, that well separated modes can be estimated directly from the power spectral density matrix at the peak.

In the FDD technique first the spectral matrix is formed from the measured outputs using simple signal processing by discrete Fourier Transform (DFT). However, instead of using the spectral density matrix directly like in the classical approach, the spectral matrix is decomposed at every frequency line using Singular Value Decomposition (SVD). By doing so the spectral matrix is decomposed into a set of auto spectral density functions, each corresponding to a single degree of freedom (SDOF) system. This is exactly true in the case where the loading is white noise, the structure is lightly damped, and where the mode shapes of close modes are geometrically orthogonal. If these assumptions are not satisfied, the decomposition into SDOF systems is an approximation, but still the results are significantly more accurate than the results of the classical approach.

The singular vectors in the SVD are used as estimates of the mode shape vectors, and the natural frequencies are estimated by taking each individual SDOF auto spectral density function back to time domain by inverse DFT. The frequency and the damping were simply estimated from the crossing times and the logarithmic decrement of the corresponding SDOF auto correlation function.

The theoretical background of the FDD technique is described in Brincker et al. [4].

### Results of Frequency Domain Decomposition (FDD)

Figure 2 shows the singular value decomposition of the spectral density matrix of the data. In this identification, the measurements had 8 channels of response data. Thus, the decomposition results in 8 singular values.

As it appears, clearly 8 peaks are visible in the decomposed spectrum. The 8 corresponding modes are easily identified using the FDD technique, and the results are shown in Figure 4.

The shape of the peaks in the decomposed spectrum might indicate that the first three identified modes might be something different from real structural modes. From the shape one might suspect that this could be harmonics. However, in the identification itself or from the

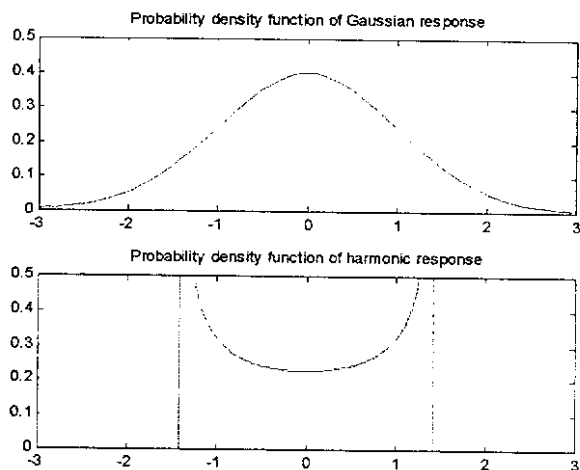

Figure 1. Theoretical probability density functions, top: structural response, bottom: harmonic response.

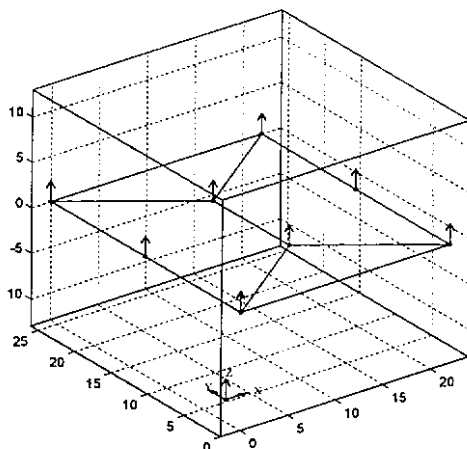

Figure 2. Transducer set-up. Distances between the three cross sections are approximately 70 m.

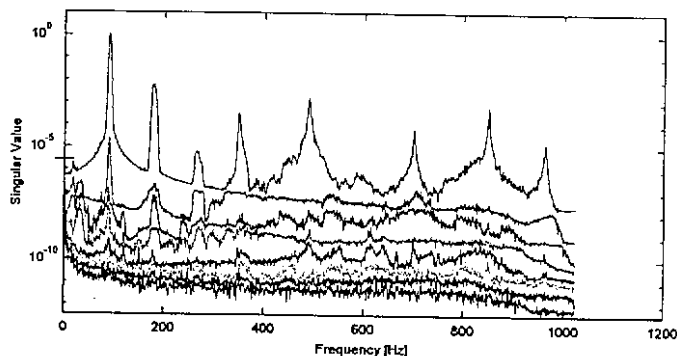

Figure 3. Singular value decomposition of the spectral density matrix of the data.

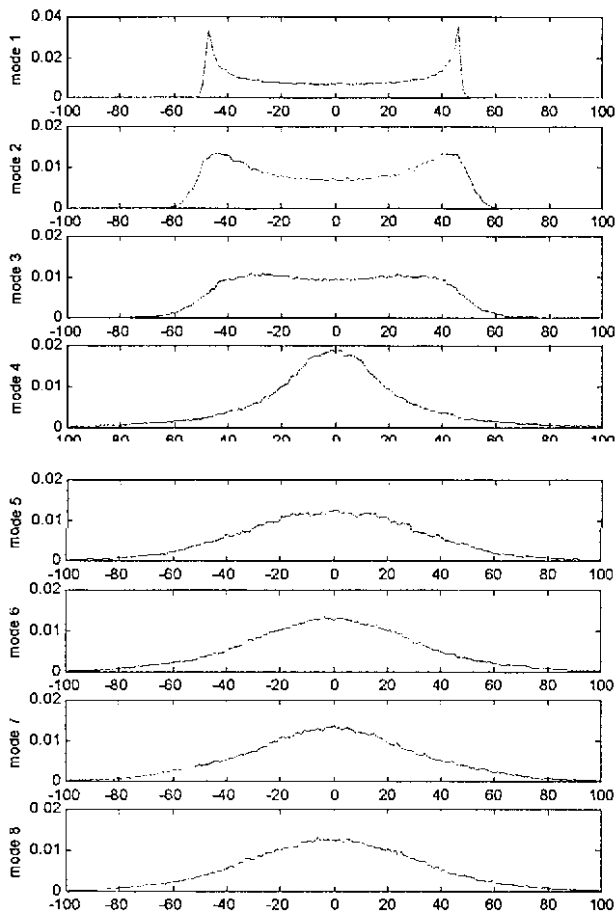

Figure 4. Empirical probability density functions for the 8 identified modes.

identification results, not much indicates that the first modes should be suspected of not being structural. Only the fact that the frequencies of the 2<sup>nd</sup> and the 3<sup>rd</sup> mode are approximately two or three times the frequency for the first mode might indicate that this could be harmonics.

### Separating Harmonic and Structural Modes

The modal response for each mode was estimated using an 8 pole digital Butterworth band-pass filter with a filter width of  $0.10 f_v$ , where  $f_v = 1024$  Hz is the Nyquist frequency and with a centre frequency equal to the natural frequency of each mode.

The empirical probability density functions for the band-pass filtered signals were then estimated. The empirical density functions are shown in Figure 4.

As it appears from the results, the three first modes are clearly identified as harmonics. For the first three modes the

density functions is a double-peak distribution. For the rest of the modes the distribution is a single-peak distribution looking like a Gaussian distribution indicating the rest of the modes as structural modes.

The results of the identification are given in Table 1.

### Conclusions

An indicator for separation of harmonics and structural modes in output-only identification has been defined and tested on a real case where a plate was loaded by engine rotations.

The test specimen was loaded only by the mounted engine, and from the in-operational responses, 8 modes were identified using a Frequency Domain Decomposition technique.

Using the defined indicator, the three first modes were identified as harmonics and the 5 remaining modes were identified as structural modes.

Based on 8 seconds of response data only, five structural modes and three harmonics were identified.

### Acknowledgements

This investigation was carried out with assistance from Gloria Martins, Technical University of Lisbon. The good company the intellectual and the emotional support is gratefully acknowledged.

### References

- [1] Ventura, Carlos E. and Tomas Horyna: "Structural Assessment by Modal Analysis in Western Canada", Proc. of the 15<sup>th</sup> International Modal Analysis Conference, Orlando, Florida, Orlando, 1997.
- [2] Andersen, P, R. Brincker, B. Peeters, G. De Roeck, L. Hermans and C. Krämer: "Comparison of system Identification Methods Using Ambient Bridge Test Data", Proc. of the 17<sup>th</sup> International Modal Analysis Conference, Kissimmee, Florida, 1999.
- [3] Ewins, D.J.: "Modal Testing: Theory and Practice", Research Studies Press Ltd., John Wiley and Sons Inc., 1995

[4] Maia, N.M.M. and J.M.M. e Silva: "Theoretical and Experimental Modal Analysis", Research Studies Press Ltd., John Wiley and Sons Inc., 1997.

[5] Brincker, R., L. Zhang and P. Andersen: "Modal Identification from Ambient Responses using Frequency Domain Decomposition, Proc. of the 18<sup>th</sup> International Modal analysis Conference, San Antonio, Texas, February 7-10, 2000.

[6] Overschee, Van P., and B. De Moor: "Subspace Identification for Linear Systems", Kluwer Academic Publishers, 1996.

[7] Lagö, T.: "The difference between harmonics and stochastic narrow band responses", oral presentation at the SVIBS symposium, Stockholm, 1997.

[8] Papoulis, A.: "Probability and Statistics", Prentice Hall International Inc., 1990.

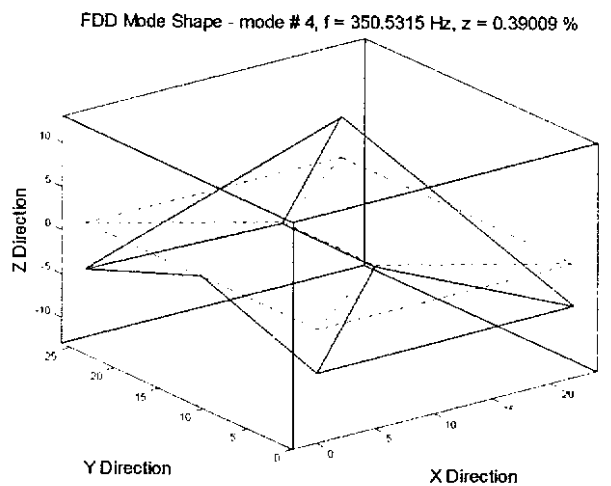
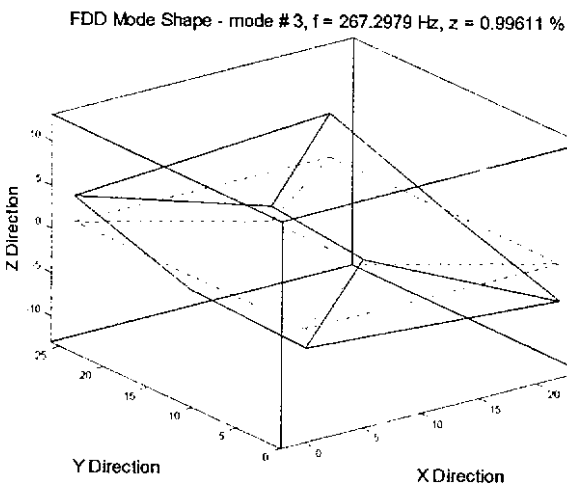
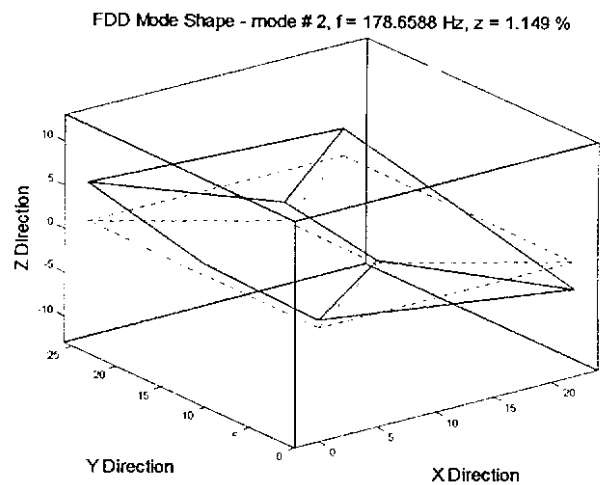
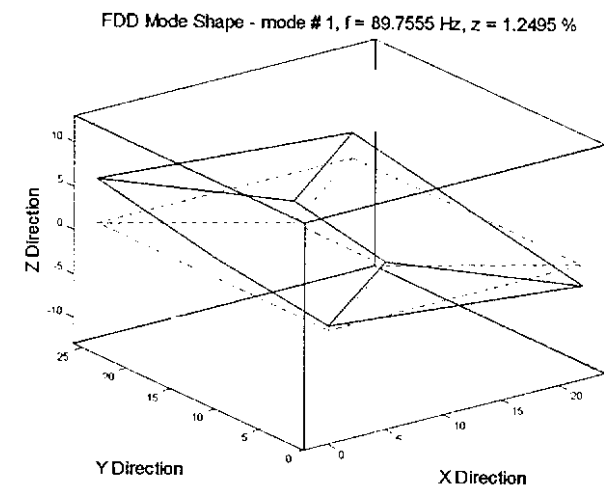

Figure 4. Identified modes including harmonics, modes 1-4.

Table 1. Final results of identification.

Mode No.	Modes Identified by Frequency Domain Decomposition (FDD)		Type of mode
	Frequency (Hz)	Damping (%)	
1	89.8	-	Harmonic
2	178.7	-	Harmonic
3	267.3	-	Harmonic
4	350.5	0.39	Structural mode
5	491.3	0.28	Structural mode
6	702.1	0.22	Structural mode
7	851.3	0.33	Structural mode
8	1006.7	6.67	Structural mode

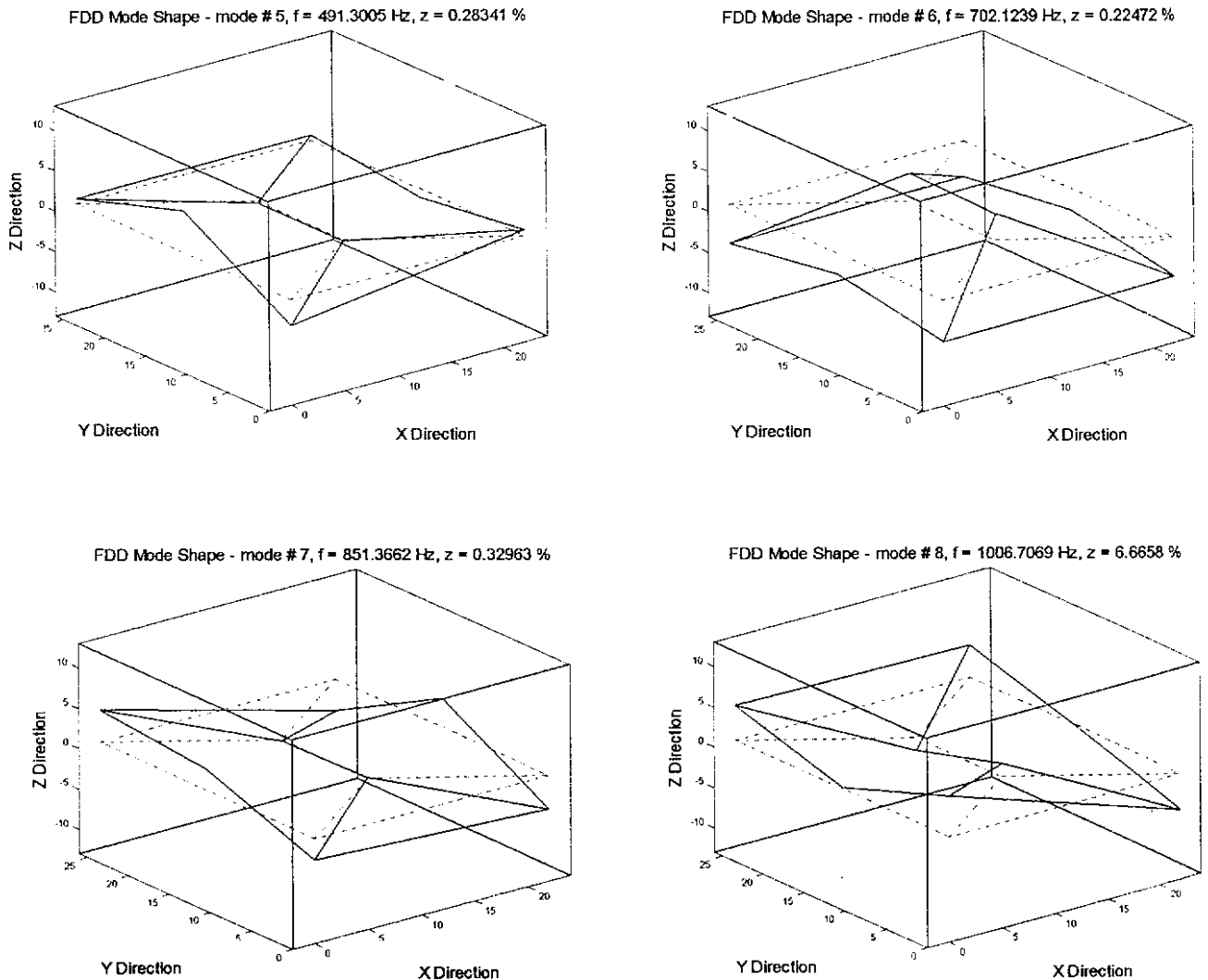

Figure 4. Identified modes including harmonics, modes 5-8.